

RA6113HEMV, RA6118HEMV

6" Horizontal Lamp Architectural Grade New Construction Compact Fluorescent Housing

Specifications/Features

Housing/Mounting

Architectural Grade 6" housing, 6-1/4" aperture.
6-1/2" Ceiling cutout. Maximum ceiling thickness: 1-1/4". Allow 3" clearance around fixture.
(4) "Trim-Lock" dimpled spring clips hold reflector in place without damaging it. Installed hanger bars span 24" and include built-in nailers as well as T-bar hooks.
Junction box is provided for wiring 4-in/4-out, with (4) 1/2" and (4) Romex pryouts, (1) 1/2" - 3/4" concentric knockout.

Lamp/Electrical

(1) 13W DTT or TRT (G24Q-1 or GX24Q-1 base) 4-PIN lamp or
(1) 18W DTT or TRT (G24Q-2 or GX24Q-2 base) 4-PIN lamp (max.).
Electronic, multi wattage ballast with high power factor (.99).
Multi Volt (120-277V) ballast.
Class P thermally protected by internal fuse in ballast.
Maximum input (13W) current: @ 120V (.13A), @ 277V (.05A).
Maximum input (18W) current: @ 120V (.15A), @ 277V (.07A).
Sound rated A.
End of lamp life protection circuit.
Surge protected, meets ANSI C62.41.
Program start for extended lamp life.

Trims

Commercial Grade trims are available in several different styles and finishes to complement your space. Commercial Grade trims have white trim flanges. Specification Grade trims have a high quality Alzak™ low iridescence finish, optically designed for maximum lumen output. Available with white painted flange in standard and premium finishes.

Warranty

This fixture is covered by Con-Tech's full one (1) year replacement guarantee after date of purchase.
Electronic ballasts have a five (5) year manufacturer's warranty.

Listing

cULus listed. Suitable for damp locations.

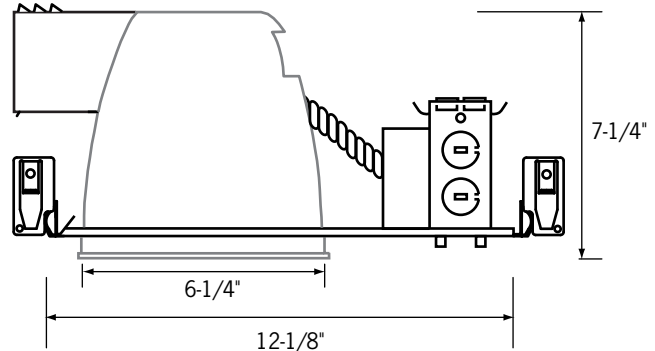

Shown with CST Series Reflector
Ceiling Opening: 6-1/2"
Plaster frame: 7-5/8" by 12-1/8" (less bar hangers)

Ordering Information

Example Order: -

Housing

RA6113HEMV - 13W DTT Housing
RA6118HEMV - 18W DTT Housing

Trims

For trim details, see "Trims for 6" Horizontal Lamp Architectural Grade Compact Fluorescent Recessed Housings" sheet.

Options

- CTR64C-CLR** - 6" Diameter Cross Hair Louver, Spring Retention Insert, Clear Specular Aluminum Finish
- DAMX** - Advance MarkX Dimming Option
- DLEC** - Lutron ECOSYSTEM Dimming Option
- EB4** - Factory Installed 4-PIN 650 Lumen Emergency Ballast with Remote Test Switch
- EB4-IS** - Factory Installed 4-PIN 650 Lumen Emergency Ballast with Internal Test Switch
- EB4R** - Remote 4-PIN 650 Lumen Emergency Ballast with Remote Test Switch
- EBH-IS** - Factory Installed 4-PIN 1300 Lumen Emergency Ballast with Internal Test Switch
- 347V** - Consult factory

Trims for 6" Horizontal Lamp Compact Fluorescent Recessed Housings

All trims are compatible with 6 Inch Horizontal Lamp Compact Fluorescent Recessed Housings: **RA6118HEMV, RA6142HEMV, RA6142HEMVR, RA6218HEMV, RA6218HEMVR, RA6226HEMV, RA6226HEMVR** and **RA6132HEMV-IC** series housings.

All trims have white trim ring finish unless specified.

All trims are cULus listed.

All trims are suitable for damp locations; only shower trims are listed for wet locations.

Specification Grade Trims

One piece ALZAK™ reflector. Spun parabolic contour provides 40° cutoff to lamp and lamp image. Optically designed for superior light control. All reflector finishes are low iridescent to eliminate the rainbowing effect. Self-flanged trim design that produces a smooth transition from fixture to ceiling. 90° wall wash cutout with wall wash kicker. Matching reflector finishes provide uniform distribution of light to the wall surface. Custom finishes are available, consult ConTech for details. White painted flange available. Add "-WPF" after the catalog number.

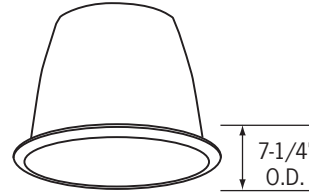

CST6422H-(CLR, PL)
 Reflector
CST6423H-(CLR, PL)
 90° Wall Wash Kicker
Finishes: -CLR (Clear), -PL (Matte Platinum)

Commercial Grade Trims

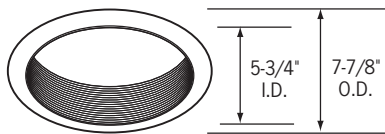

CTR6421H-B
 Black Baffle, Clear Reflector, Black Trim Ring

CTR6421H-P
 Black Baffle, Clear Reflector, White Trim Ring

CTR6421H-P-WHT
 White Baffle, White Reflector, White Trim Ring

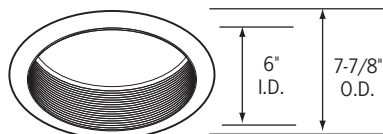

CTR6427H-P
 Black Baffle Trim

CTR6427H-WHT
 White Baffle Trim

Clear specular reflector with regressed prismatic convex glass lens; 1-1/2" regress. Aluminum baffle and reflector. Wet location listed.

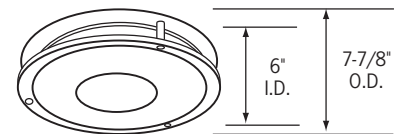

CTR6426H-P
 Floating Ring with White Reflector, 1-1/2" Drop, 3-1/2" Center Hole.

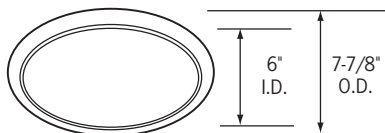

CTR6422H-CLR
 Clear Specular Reflector

CTR6422H-WHT
 White Specular Reflector

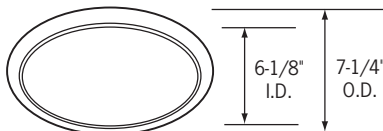

CTR6428H-CLR
 Clear Finish Self-flanged Specular Reflector

CTR6428H-PL
 Platinum Finish Self-flanged Specular Reflector
Not Compatible with Remodel Style Housings:
RA6142HEMVR, RA6218HEMVR or RA6226HEMVR.

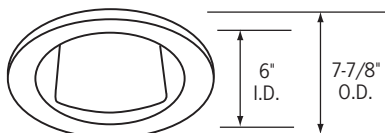

CTR6423H-CLR
 Wall Wash Kickplate, Clear Reflector, White Plastic Trim Ring



CTR6425H-P
 Floating Glass Trim with White Reflector, 1-1/2" Drop from ceiling.

Reflector/Trim Finishes

Reflector Finish Options:

CLR - Clear **PL** - Matte Platinum
WHT - White

Trim Finish Options:

B - Black **P** - White

RA6113HEMV, RA6118HEMV

6" Horizontal Lamp Architectural Grade
 New Construction Compact Fluorescent Housing

Trim: **CST6422H-CLR** Specification Grade Clear Specular Finish Reflector

Lamp: (1) 18W DTT Lumens: 1250 per lamp Spacing Criteria: 1.4 Test No.: 65646

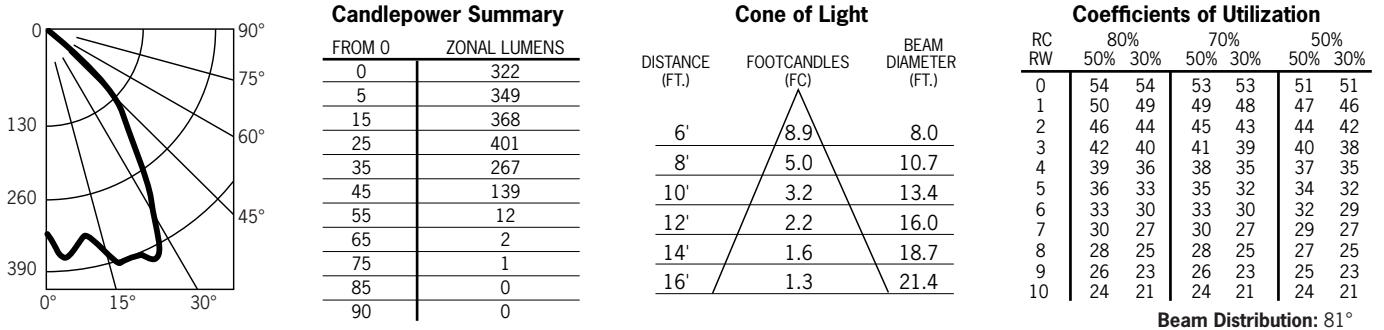

Trim: **CST6422H-PL** Specification Grade Matte Platinum Finish Reflector

Lamp: (1) 18W DTT Lumens: 1250 per lamp Spacing Criteria: 1.2 Test No.: 65647

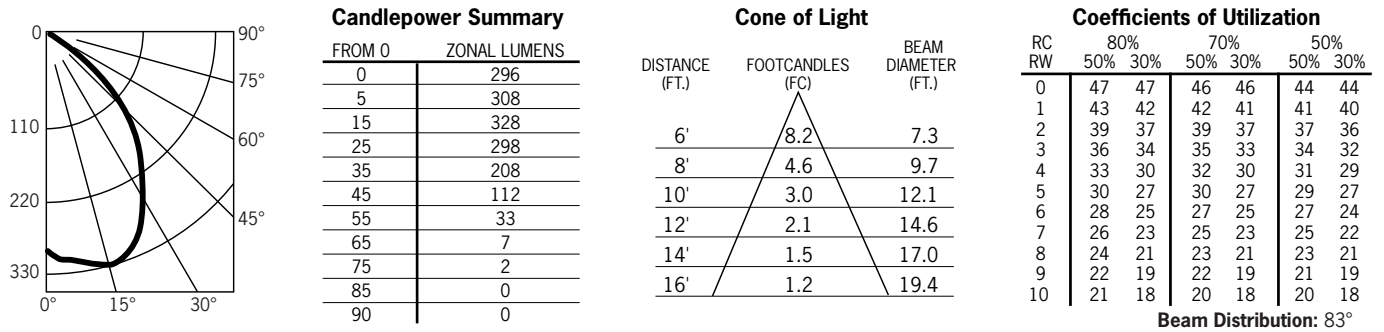

Trim: **CTR6421H-P-WHT** White Baffle Trim with White Reflector

Lamp: (1) 18W DTT Lumens: 1250 per lamp Spacing Criteria: 1.0 Test No.: 65649

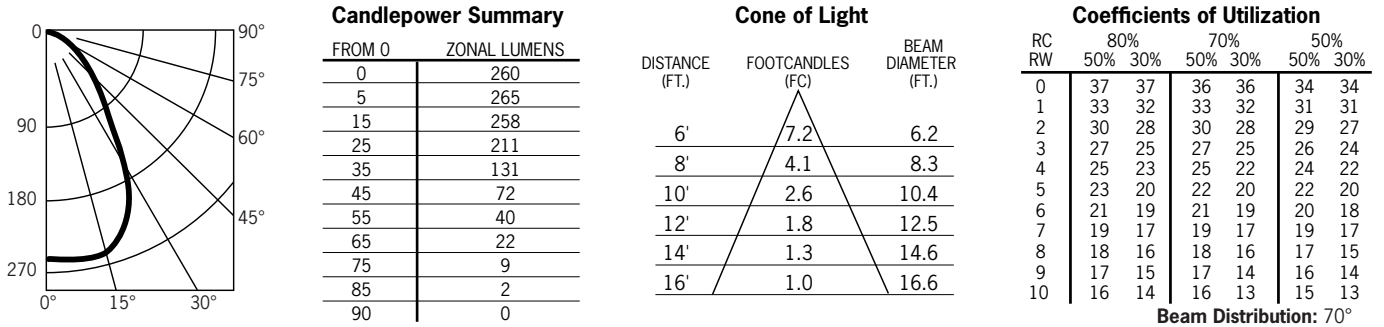

Trim: **CTR6422H-CLR** Clear Specular Multiplier

Lamp: (1) 18W DTT Lumens: 1250 per lamp Spacing Criteria: 1.4 Test No.: 65648

