

LVR316RML

3" StopAire® Low Voltage Downlight Remodel Style Housing with 8W LED MR16 Lamp

Specifications/Features

Housing

Low silhouette design for remodeling applications in solid or suspended ceilings. Narrow fixture design for fast installation through ceiling opening minimizes remodeling mess. Retractable mounting clips allow easy installation into existing ceiling. Fixture is easily installed through ceiling opening. Retractable mounting clips lock fixture in place and adjust for different ceiling thicknesses from 1/2" to 1".

Lamp/Electrical

Energy efficient, 8W MR16 LED lamp.
Designed to last 25,000 hours.
Color management system maintains color consistency over time and temperature. Correlated Color Temperature of 2700K, 3000K, and 3500K, Color Rendering Index of 82.
Correlated Color Temperature of 4000K, Color Rendering Index of 85.
High CRI of 95+ available in 3000K.
12° Lumen output = 450 (56 Lm/W)
24° Lumen output = 600 (75 Lm/W), 520 (65Lm/W) for high CRI lamp
36° Lumen output = 600 (75 Lm/W), 520 (65Lm/W) for high CRI lamp
12° Beam spread with CBCP of 5,500.
24° Beam spread with CBCP of 3,000; 2,550 for high CRI lamp.
36° Beam spread with CBCP of 1,800; 1,300 for high CRI lamp.
Durable die-cast aluminum housing with lens to protect the LEDs and reflector.
Class H "in-line" magnetic transformer is prewired and thermally protected. 120V in/12V out. Conveniently mounted to end of Junction Box and is replaceable to simplify future maintenance.
(6) 1/2" knock outs and spring latch access plates in Junction Box.
Lamp housing is removable through ceiling aperture to access Junction Box.

Dimming

Dimmable to 10% with a electronic low-voltage (ELV) dimmer. Dimming performance may vary due to field conditions, including but not limited to, power quality, installation and wiring, and variations in dimmer production. Please reference the dimmer manufacturer's instructions for dimmer installation and further information.

Trims

Many trim options available to suit a broad range of applications. See "Trims for 3" Low Voltage Recessed Housings" spec sheet for details.

Warranty

This complete fixture is covered by ConTech's full three (3) year replacement guarantee after date of purchase.

Listing

cULus listed. Suitable for damp locations.
Flood and Wide Flood Lamps are Energy Star Listed.
City of Chicago approved, CCEA listed, when CP option is selected.
Conforms to Washington State Energy Code (WSEC) for low air filtration. Tested in accordance with ASTM E283 (2.0 CFM or less).

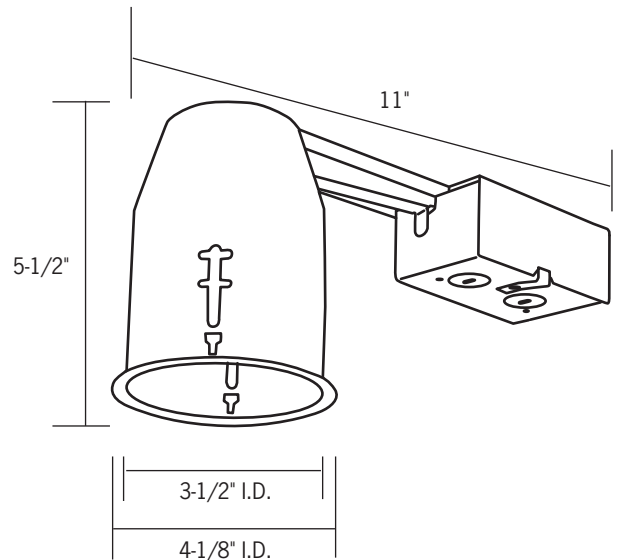

Ordering Information

Example Order:

Housing

Lamp

Trim

LVR316R - 120V/12V

- | | |
|------------------------------------|-------------------------------------|
| ML1227K - 12°, 2700K, 82CRI | ML2440K - 24°, 4000K, 85CRI |
| ML1230K - 12°, 3000K, 82CRI | ML3627K - 36°, 2700K, 82CRI |
| ML1235K - 12°, 3500K, 82CRI | ML3630K - 36°, 3000K, 82CRI |
| ML1240K - 12°, 4000K, 85CRI | ML3635K - 36°, 3500K, 82CRI |
| ML2427K - 24°, 2700K, 82CRI | ML3640K - 36°, 4000K, 85CRI |
| ML2430K - 24°, 3000K, 82CRI | ML2430KC - 24°, 3000K, 95CRI |
| ML2435K - 24°, 3500K, 82CRI | ML3630KC - 36°, 3000K, 95CRI |

See "Trims for 3" LED Recessed Downlights" sheet for trim information and details.

Trims for 3" LED Recessed Housings

All trims have white trim finish unless specified.

All trims are cCSAus certified and suitable for damp locations; only shower trims are listed for wet locations.

On recessed trims designed for use with MR16 lamps, ConTech Lighting provides a clear, tempered safety glass. This safety glass should only be used with open MR16 lamps, and not used with MR16 lamps that contain an integral glass lens. If use of MR16 with front glass is required, remove the factory provided clear tempered safety lens. Glass lens should also be removed when using MR16 LED lamps.

For LED lamp compatibility, please consult factory.

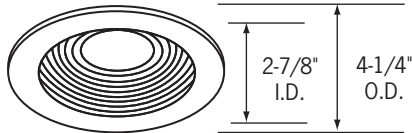

CTR301-B

Adjustable Black Baffle, Black Trim

CTR301-P

Adjustable Black Baffle

CTR301-WHT

Adjustable White Baffle

15° Vertical swing, 45mm lens. Trim can hold up to two (2) lenses with stepped lens holder (included). Insert 45mm lens on lower level of lamp seat, insert 50mm lens onto higher level.

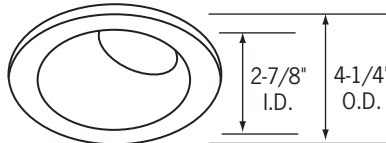

CTR304-B-BL

Angled Wall Wash; Black Reflector

CTR304-P-CLR

Angled Wall Wash; Clear Specular Reflector

CTR304-S-PL

Angled Wall Wash; Platinum Reflector, Silver Trim
Adjustable lampholder with 55-75° aiming angle. 45mm Lens. Trim can hold up to two (2) lenses with stepped lens holder (included). Insert 45mm lens on lower level of lamp seat, insert 50mm lens onto higher level.

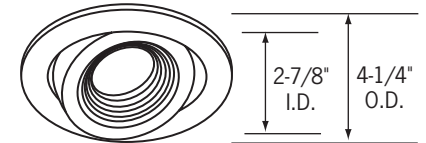

CTR307-(P, B, NK)

Adjustable Pin Spot; Black Baffle, Select Trim Finish

CTR307-WHT

Adjustable Pin Spot; White Baffle, White Trim

Deep baffle for maximum lamp concealment. May be used as a pin spot style downlight or an adjustable accent light. 35° Vertical adjustment. 45mm Lens. Trim can hold up to two (2) lenses with stepped lens holder (included). Insert 45mm lens on lower level of lamp seat, insert 50mm lens onto higher level.

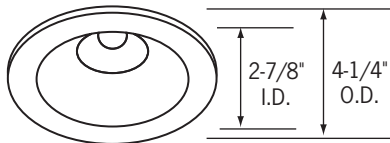

CTR302-B-BLK

Adjustable Multiplier; Black Metal Trim Ring, Black Reflector

CTR302-P-(CLR, BLK, WHT)

Adjustable Multiplier; White Metal Trim Ring, Select Reflector Finish

CTR302-(ST, NK)-CLR

Adjustable Multiplier; Select Metal Trim Finish, Clear Reflector

37° Vertical adjustment, 45mm lens. Trim can hold up to two (2) lenses with stepped lens holder (included). Insert 45mm lens on lower level of lamp seat, insert 50mm lens onto higher level.

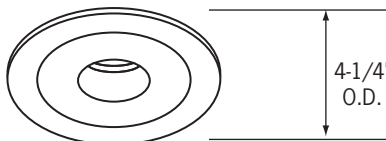

CTR305-B-BLK

Pin Spot; Black Cut-Off Reflector, Black Trim Ring

CTR305-CLR

Pin Spot; Clear Cut-Off Reflector

Downlight Only, 50mm Lens. Trim can hold up to two (2) lenses with stepped lens holder (included). Insert 45mm lens on lower level of lamp seat, insert 50mm lens onto higher level.

1-3/8" Aperture

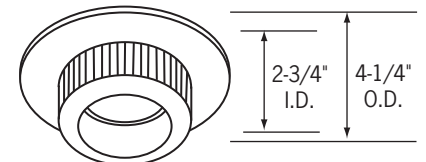

CTR310-F-P

Fluted Frosted Glass Diffuser

Must use Front Glass MR16 Lamp. 1-1/4" Drop from ceiling. Cylindrical shape focuses light downward, eliminates glare.

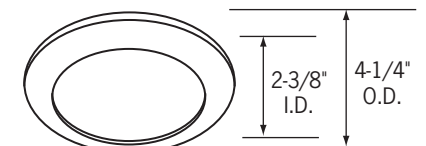

CTR311FR-(NK, P)

Frosted Flat Glass; Select Trim Finish

Shower light trim, double neoprene gasketed. cULus Listed for wet location.



CTR303N-B

Slotted Wall Wash; Black Trim

CTR303N-P

Slotted Wall Wash; White Trim

Internal 50° swing adjustment (25° from Nadir), external 358° rotation. Slot aperture permits maximum beam area adjustment for either wall wash or concealed accent lighting effects. Black interior surface.

1-3/8" x 2-1/2"
Oblong Slot

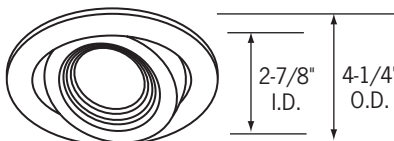

CTR306-P

Surface Adjustable; Black Baffle

40° Vertical adjustment, 359° horizontal rotation. 50mm Lens. Regressed black baffle reduces surface brightness. Flat, stainless mounting clips hold trim firmly to ceiling. Trim can hold up to two (2) lenses with stepped lens holder (included). Insert 45mm lens on lower level of lamp seat, insert 50mm lens onto higher level.

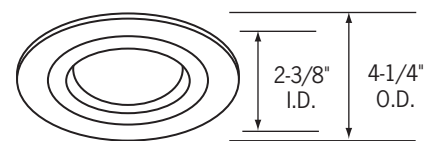

CTR312-P

Flat Glass; White Trim

Etched Glass for light diffusion.

Continued on page 2

Trims for 3" LED Recessed Housings

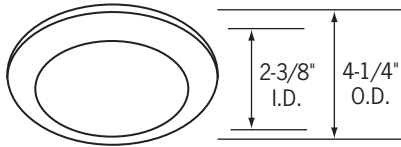

CTR313-P

Convex Drop Lens; Select Trim Finish
Shower light trim. 3/4" Drop (ceiling to bottom of glass), double neoprene gasketed. cULus listed for wet location.

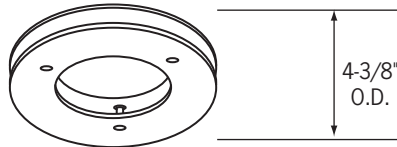

CTR317-P

Floating Ring; White Trim
Decorative floating glass ring, 2" center opening. Clear reflector with diffuse plastic cone. 1-1/8" Drop from ceiling. Cast aluminum trim construction. 50mm Lens.

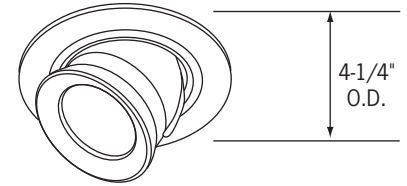

CTR325-(P, B, NK)

Fully Adjustable; Select Finish
Die cast, fully adjustable, round lampholder and backplate. Easy relamping with twist-off front retaining ring. Unsurpassed aiming flexibility: 87° vertical, 359° rotational. 50mm lens.

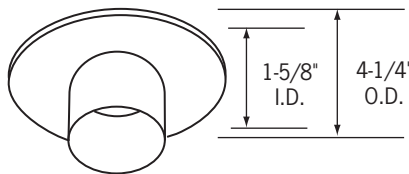

CTR321-F-(NK, P)

Frosted Glass Cylinder; Select Trim finish
Cylindrical glass diffuser, specular reflector. Light is focused downward, glare is eliminated. Cast aluminum trim construction. 1-1/4" Drop from ceiling.

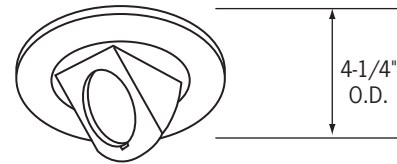

CTR324-(P, NK, ST)

Fully Adjustable; Select Finish
Unsurpassed aiming flexibility: 87° vertical, 359° rotational. Front access, spring latch lamp retainer ring, black finish (optional white retainer ring available: **1623/224 WHITE**, ordered separately). Exclusive stainless flat springs insure firm, close-to-ceiling mounting. Accepts only one 47mm lens; if louver is required (**FA-16 45MM**), remove safety lens and use front glass MR16 lamp.

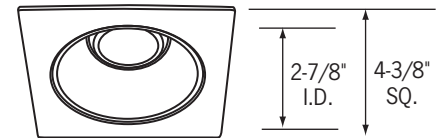

CTR302SQ-B-(BLK, CLR)

Adjustable Multiplier; Black Trim, Black or Clear Reflector

CTR302SQ-P-(CLR, WHT)

Adjustable Multiplier; White Trim, Clear or White Reflector

Multipliers utilize a highly polished, specular reflector to maximize light intensity while concealing the light source. May be used as a downlight or adjustable accent light.

37° Vertical adjustment, 45mm lens. Trim can hold up to two (2) lenses with stepped lens holder (included). Insert 45mm lens on lower level of lamp seat, insert 50mm lens onto higher level.



CTR335-(B, CO, P)

Elbow; Select Finish
Exceptional aiming flexibility with 87° vertical, 359° rotation adjustment. Die-cast aluminum construction. Front access, spring latch lamp retainer ring, black finish (optional white retainer ring available: **1623/224 WHITE**, ordered separately). Maximum depth from ceiling: 2-1/2". 47mm lens. Accepts only one 47mm lens; if louver is required (**FA-16 45MM**), remove safety lens and use front glass MR16 lamp.

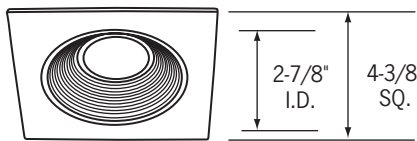

CTR301SQ-B

Adjustable Black Baffle, Black Trim

CTR301SQ-P

Adjustable Black Baffle, White Trim

CTR301SQ-WHT

Adjustable White Baffle, White Trim

Deep baffle traps stray light and conceals the lamp. May be used as a downlight or adjustable accent light 15° Vertical swing, 45mm lens. Trim can hold up to two (2) lenses with stepped lens holder (included). Insert 45mm lens on lower level of lamp seat, insert 50mm lens onto higher level.

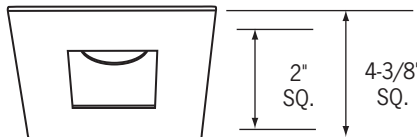

CTR305SQ-SQ-B-CLR

Square Pin Spot, Black Trim, Clear Reflector

CTR305SQ-SQ-P-CLR

Square Pin Spot, White Trim, Clear Reflector

CTR305SQ-SQ-NK-CLR

Square Pin Spot, Brushed Nickel Trim, Clear Reflector

Downlight Only, 50mm Lens.



CTR306SQ-B

Surface Adjustable Black Trim; Black Baffle

CTR306SQ-P

Surface Adjustable White Trim; Black Baffle

40° Vertical adjustment, 359° horizontal rotation. 50mm Lens. Regressed black baffle reduces surface brightness. Flat, stainless mounting clips hold trim firmly to ceiling.

Reflector/Trim Finish Legend

All finishes are not available for all trims.

Reflector Finish Options:

BLK - Black Specular CLR - Clear Specular
PL - Matte Platinum WHT - White Specular

Trim Finish Options:

B - Black NK - Nickel
BC - Black Chrome P - White
C - Chrome S - Silver
CO - Brushed Copper ST - Brushed Stainless Steel