

# LVR316R-SA 10M

**StopAire® Low Voltage Recessed Remodel Downlight; Housing Only  
For Use With 10W Max. LED Lamps**

## Specifications/Features

### Housing/Mounting

Low silhouette design for remodeling applications in solid or suspended ceilings.

Narrow fixture design for fast installation through ceiling opening minimizes remodeling mess.

Retractable mounting clips allow easy installation into existing ceiling.

Fixture is easily installed through ceiling opening.

Retractable mounting clips lock fixture in place and adjust for different ceiling thicknesses from 1/2" to 1".



### Lamp/Electrical

(1) 12V 10W Max. MR16, GU5.3 base.

Class H "in-line" magnetic transformer is prewired and thermally protected. 120V in/12V out. Conveniently mounted to end of J-Box and is replaceable to simplify future maintenance.

(6) 1/2" knock outs and spring latch access plates in J-box.

Lamp housing is removeable through ceiling aperture for access to J-Box. Can be used with low voltage, magnetic dimming controls for optimal control of illumination.

Ceramic terminal block socket.

### Trims

Baffle, multiplier, wall wash, accent and adjustable trim options available to suit a broad range of applications. See "Trims for 3" Low Voltage Recessed Housings" spec sheet for details.

### Warranty

This fixture is covered by ConTech's full one (1) year replacement guarantee after date of purchase.

### Labels/Usage

cCSAus Certified. Suitable for damp locations.

Conforms to Washington State Energy Code (WSEC) for low air filtration.

Tested in accordance with ASTM E283 (2.0 CFM or less).

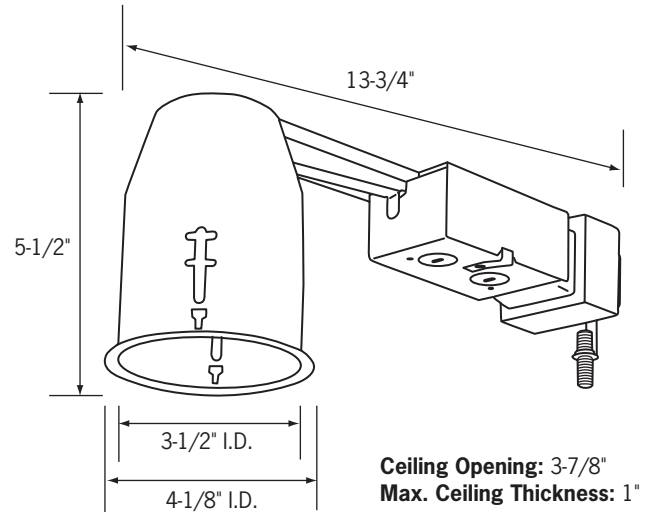

## Ordering Information

Example Order:

Housing/Voltage

**LVR316R-SA 10M** - 120V/12V/10W

Trims

**For Trims, see "Trims for 3" Low Voltage Recessed Housings" spec sheet.**

## Trims for 3" LED Recessed Housings

**All trims have white trim finish unless specified.**

All trims are cCSAus certified and suitable for damp locations; only shower trims are listed for wet locations.

On recessed trims designed for use with MR16 lamps, ConTech Lighting provides a clear, tempered safety glass. This safety glass should only be used with open MR16 lamps, and not used with MR16 lamps that contain an integral glass lens. If use of MR16 with front glass is required, remove the factory provided clear tempered safety lens. Glass lens should also be removed when using MR16 LED lamps.

For LED lamp compatibility, please consult factory.

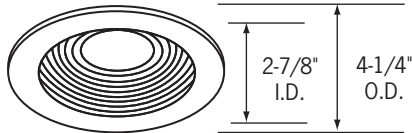

**CTR301-B**

Adjustable Black Baffle, Black Trim

**CTR301-P**

Adjustable Black Baffle

**CTR301-WHT**

Adjustable White Baffle

15° Vertical swing, 45mm lens. Trim can hold up to two (2) lenses with stepped lens holder (included). Insert 45mm lens on lower level of lamp seat, insert 50mm lens onto higher level.

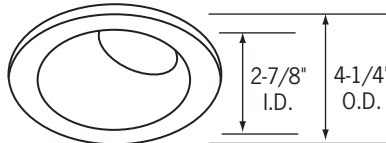

**CTR304-B-BL**

Angled Wall Wash; Black Reflector

**CTR304-P-CLR**

Angled Wall Wash; Clear Specular Reflector

**CTR304-S-PL**

Angled Wall Wash; Platinum Reflector, Silver Trim  
Adjustable lampholder with 55-75° aiming angle. 45mm Lens. Trim can hold up to two (2) lenses with stepped lens holder (included). Insert 45mm lens on lower level of lamp seat, insert 50mm lens onto higher level.

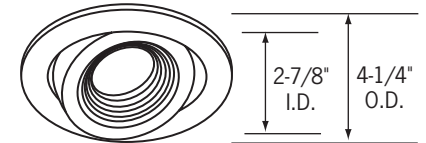

**CTR307-(P, B, NK)**

Adjustable Pin Spot; Black Baffle, Select Trim Finish

**CTR307-WHT**

Adjustable Pin Spot; White Baffle, White Trim

Deep baffle for maximum lamp concealment. May be used as a pin spot style downlight or an adjustable accent light. 35° Vertical adjustment. 45mm Lens. Trim can hold up to two (2) lenses with stepped lens holder (included). Insert 45mm lens on lower level of lamp seat, insert 50mm lens onto higher level.

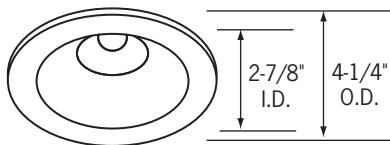

**CTR302-B-BLK**

Adjustable Multiplier; Black Metal Trim Ring, Black Reflector

**CTR302-P-(CLR, BLK, WHT)**

Adjustable Multiplier; White Metal Trim Ring, Select Reflector Finish

**CTR302-(ST, NK)-CLR**

Adjustable Multiplier; Select Metal Trim Finish, Clear Reflector

37° Vertical adjustment, 45mm lens. Trim can hold up to two (2) lenses with stepped lens holder (included). Insert 45mm lens on lower level of lamp seat, insert 50mm lens onto higher level.

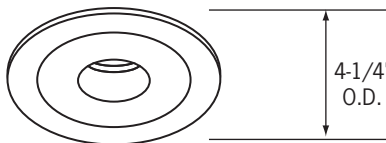

**CTR305-B-BLK**

Pin Spot; Black Cut-Off Reflector, Black Trim Ring

**CTR305-CLR**

Pin Spot; Clear Cut-Off Reflector

Downlight Only, 50mm Lens. Trim can hold up to two (2) lenses with stepped lens holder (included). Insert 45mm lens on lower level of lamp seat, insert 50mm lens onto higher level.

1-3/8" Aperture

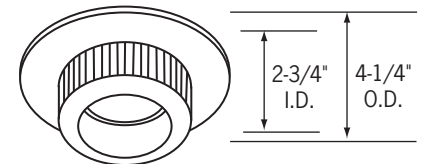

**CTR310-F-P**

Fluted Frosted Glass Diffuser

**Must use Front Glass MR16 Lamp.** 1-1/4" Drop from ceiling. Cylindrical shape focuses light downward, eliminates glare.

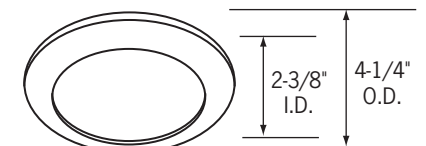

**CTR311FR-(NK, P)**

Frosted Flat Glass; Select Trim Finish

Shower light trim, double neoprene gasketed. cULus Listed for wet location.

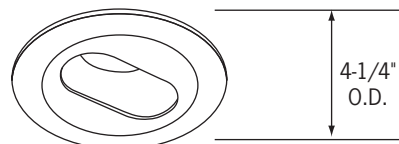

**CTR303N-B**

Slotted Wall Wash; Black Trim

**CTR303N-P**

Slotted Wall Wash; White Trim

Internal 50° swing adjustment (25° from Nadir), external 358° rotation. Slot aperture permits maximum beam area adjustment for either wall wash or concealed accent lighting effects. Black interior surface.

1-3/8" x 2-1/2"  
Oblong Slot

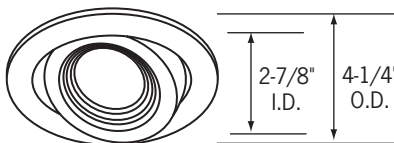

**CTR306-P**

Surface Adjustable; Black Baffle

40° Vertical adjustment, 359° horizontal rotation. 50mm Lens. Regressed black baffle reduces surface brightness. Flat, stainless mounting clips hold trim firmly to ceiling. Trim can hold up to two (2) lenses with stepped lens holder (included). Insert 45mm lens on lower level of lamp seat, insert 50mm lens onto higher level.

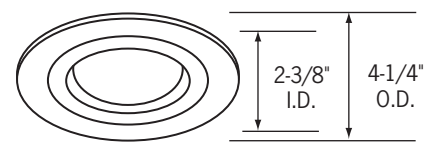

**CTR312-P**

Flat Glass; White Trim

Etched Glass for light diffusion.

*Continued on page 2*

## Trims for 3" LED Recessed Housings

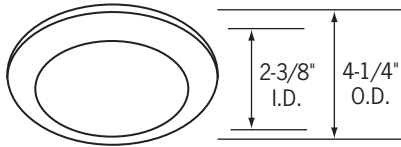

### CTR313-P

Convex Drop Lens; Select Trim Finish  
Shower light trim. 3/4" Drop (ceiling to bottom of glass), double neoprene gasketed. cULus listed for wet location.

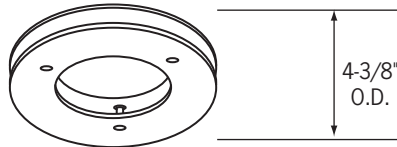

### CTR317-P

Floating Ring; White Trim  
Decorative floating glass ring, 2" center opening. Clear reflector with diffuse plastic cone. 1-1/8" Drop from ceiling. Cast aluminum trim construction. 50mm Lens.

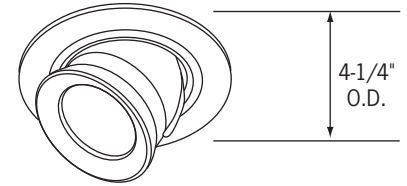

### CTR325- (P, B, NK)

Fully Adjustable; Select Finish  
Die cast, fully adjustable, round lampholder and backplate. Easy relamping with twist-off front retaining ring. Unsurpassed aiming flexibility: 87° vertical, 359° rotational. 50mm lens.

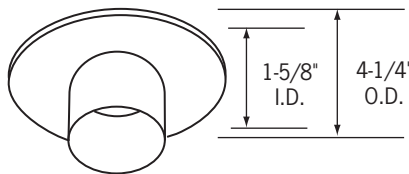

### CTR321-F-(NK, P)

Frosted Glass Cylinder; Select Trim finish  
Cylindrical glass diffuser, specular reflector. Light is focused downward, glare is eliminated. Cast aluminum trim construction. 1-1/4" Drop from ceiling.

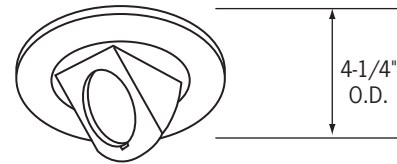

### CTR324- (P, NK, ST)

Fully Adjustable; Select Finish  
Unsurpassed aiming flexibility: 87° vertical, 359° rotational. Front access, spring latch lamp retainer ring, black finish (optional white retainer ring available: **1623/224 WHITE**, ordered separately). Exclusive stainless flat springs insure firm, close-to-ceiling mounting. Accepts only one 47mm lens; if louver is required (**FA-16 45MM**), remove safety lens and use front glass MR16 lamp.

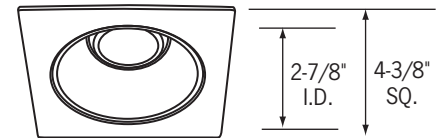

### CTR302SQ-B-(BLK, CLR)

Adjustable Multiplier; Black Trim, Black or Clear Reflector

### CTR302SQ-P-(CLR, WHT)

Adjustable Multiplier; White Trim, Clear or White Reflector

Multipliers utilize a highly polished, specular reflector to maximize light intensity while concealing the light source. May be used as a downlight or adjustable accent light.

37° Vertical adjustment, 45mm lens. Trim can hold up to two (2) lenses with stepped lens holder (included). Insert 45mm lens on lower level of lamp seat, insert 50mm lens onto higher level.

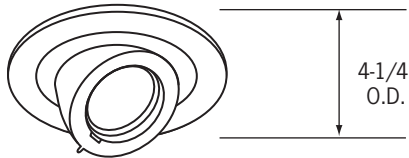

### CTR335-(B, CO, P)

Elbow; Select Finish  
Exceptional aiming flexibility with 87° vertical, 359° rotation adjustment. Die-cast aluminum construction. Front access, spring latch lamp retainer ring, black finish (optional white retainer ring available: **1623/224 WHITE**, ordered separately). Maximum depth from ceiling: 2-1/2". 47mm lens. Accepts only one 47mm lens; if louver is required (**FA-16 45MM**), remove safety lens and use front glass MR16 lamp.

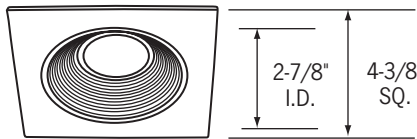

### CTR301SQ-B

Adjustable Black Baffle, Black Trim

### CTR301SQ-P

Adjustable Black Baffle, White Trim

### CTR301SQ-WHT

Adjustable White Baffle, White Trim

Deep baffle traps stray light and conceals the lamp. May be used as a downlight or adjustable accent light 15° Vertical swing, 45mm lens. Trim can hold up to two (2) lenses with stepped lens holder (included). Insert 45mm lens on lower level of lamp seat, insert 50mm lens onto higher level.

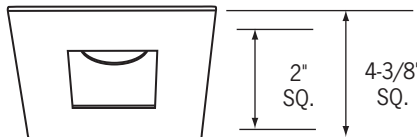

### CTR305SQ-SQ-B-CLR

Square Pin Spot, Black Trim, Clear Reflector

### CTR305SQ-SQ-P-CLR

Square Pin Spot, White Trim, Clear Reflector

### CTR305SQ-SQ-NK-CLR

Square Pin Spot, Brushed Nickel Trim, Clear Reflector

Downlight Only, 50mm Lens.



### CTR306SQ-B

Surface Adjustable Black Trim; Black Baffle

### CTR306SQ-P

Surface Adjustable White Trim; Black Baffle

40° Vertical adjustment, 359° horizontal rotation. 50mm Lens. Regressed black baffle reduces surface brightness. Flat, stainless mounting clips hold trim firmly to ceiling.

### Reflector/Trim Finish Legend

All finishes are not available for all trims.

#### Reflector Finish Options:

BLK - Black Specular CLR - Clear Specular  
PL - Matte Platinum WHT - White Specular

#### Trim Finish Options:

B - Black NK - Nickel  
BC - Black Chrome P - White  
C - Chrome S - Silver  
CO - Brushed Copper ST - Brushed Stainless Steel