

CTL8081

10W LED Track Fixture

Specifications/Features

Fixture

Small scale, 10W LED Track Fixture delivering up to 725 lumens. Constructed of a cast aluminum heat-sink head and a horizontally oriented polycarbonate driver housing. Dimming is standard. Precision aiming adjustment. 340°+ aiming horizontal rotation, 90° vertical rotation.

Lamp

Light engine consists of a single, high lumen output multi-chip LED array. Available in the following color temperatures:
 2700K; CRI 80 min., 83 Typical
 3000K; CRI 80 min., 83 Typical
 3500K; CRI 80 min., 83 Typical
 4000K; CRI 80 min., 83 Typical

Excellent fixture to fixture color consistency within a 3-step MacAdam Ellipse tolerance. Available in Spot (15°), Medium (24°) and Flood (35°) beam distributions. Each beam option is achieved utilizing molded TIR optics providing smooth uniform beams. System designed and rated for 50,000 hours at 70% lumen maintenance.

Electrical

10W Driver Specifications:
 Input Wattage 10W
 Input Voltage: 120VAC, 50/60Hz
 Dimming: TRIAC Forward Phase (Incandescent)

Warranty

This complete fixture is covered by ConTech's full five (5) year replacement guarantee after date of purchase.

Listing

cCSAus Certified to UL standards. Suitable for dry locations.

Fixture Compatibility

Standard ConTech track fixtures are CSA Listed as-is for use with ConTech's many track systems, as well as with Juno Lighting track.

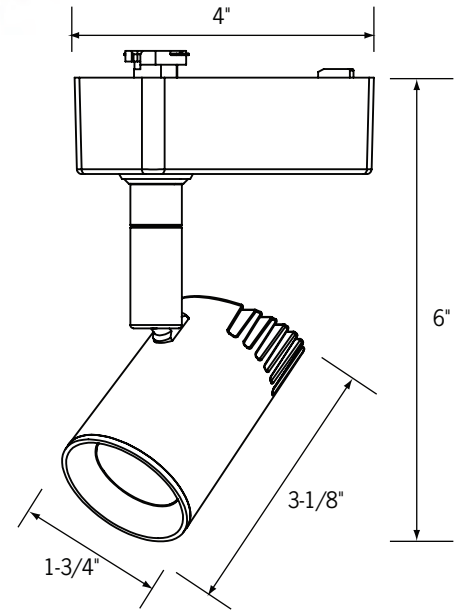

Ordering Information

Example Order: -

Fixture	Beam	Color Temp	Dimming	Finish
<input type="text"/>	<input type="text"/>	<input type="text"/>	<input type="text"/>	<input type="text"/>
CTL8081H - 10W	S - 15° Spot M - 24° Medium F - 35° Flood	27 - 2700K 3 - 3000K 35 - 3500K 4 - 4000K	D - Dimming	B - Black P - White S - Silver

CTL8081

10W LED Track Fixture

Photometrics

Lumen output values fluctuate based on CCT and CRI. To estimate lumen output of the various CCT/CRI options, multiply 3000K (80 CRI min) results by the following:

CCT	Standard CRI
2700K	.935
3000K	N/A
3500K	1.0
4000K	1.07

CTL8081HS3D

Designed for 50,000 Hour Lamp Life¹; LM-63 Test No. 82863

Light Output (Fixture Delivered Lumens): 669
Total Watts@120V: 10.2; **Lumens Per Watt:** 65.6
Center Beam Candle Power: 3803
Color Rendering Index (CRI)²: 81
Color Temperature (CCT)³: 2997K Warm White
Spectral Power Distribution Chart⁴

LM-79 Test No. 82866

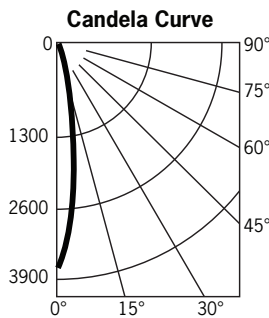
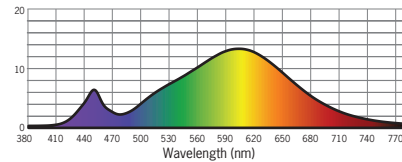

Candlepower Summary

FROM 0	CANDELA	LUMENS
0	3803	
5	2492	204
15	871	240
25	251	122
35	92	59
45	30	24
55	13	12
65	6	6
75	2	2
85	0	0
95	0	0

Intensity Distribution

DISTANCE (FT.)	FOOTCANDLES (FC)	BEAM DIAMETER (FT.)
6'	105.6	1.5
8'	59.4	2.0
10'	38.0	2.5
12'	26.4	3.0
14'	19.4	3.4
16'	14.9	3.9

Beam Distribution: 15°

CTL8081HM3D

Designed for 50,000 Hour Lamp Life¹; LM-63 Test No. 82864

Light Output (Fixture Delivered Lumens): 720
Total Watts@120V: 10.2; **Lumens Per Watt:** 70.6
Center Beam Candle Power: 3917
Color Rendering Index (CRI)²: 81
Color Temperature (CCT)³: 2997K Warm White
Spectral Power Distribution Chart⁴

LM-79 Test No. 82866

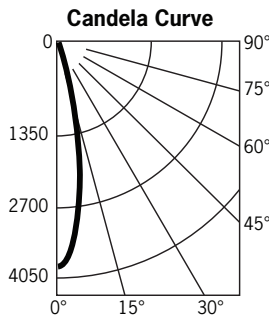
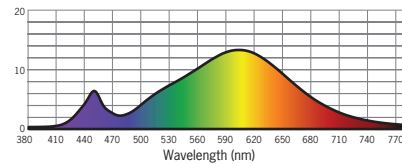

Candlepower Summary

FROM 0	CANDELA	LUMENS
0	3917	
5	3529	290
15	861	256
25	174	89
35	76	47
45	25	21
55	11	10
65	4	4
75	1	1
85	0	0
95	0	0

Intensity Distribution

DISTANCE (FT.)	FOOTCANDLES (FC)	BEAM DIAMETER (FT.)
6'	108.8	2.2
8'	61.2	2.9
10'	39.2	3.6
12'	27.2	4.3
14'	20.0	5.0
16'	15.3	5.7

Beam Distribution: 21°

CTL8071F3D

Designed for 50,000 Hour Lamp Life¹; LM-63 Test No. 82865

Light Output (Fixture Delivered Lumens): 725
Total Watts@120V: 10.2; **Lumens Per Watt:** 71.1
Center Beam Candle Power: 2387
Color Rendering Index (CRI)²: 81
Color Temperature (CCT)³: 2997K Warm White
Spectral Power Distribution Chart⁴

LM-79 Test No. 82866

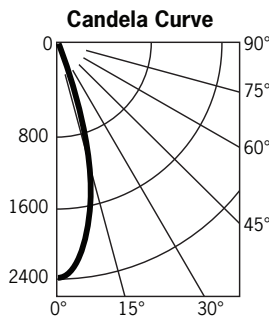
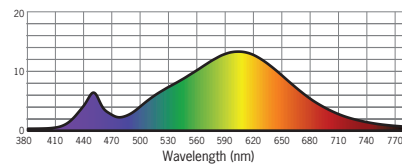

Candlepower Summary

FROM 0	CANDELA	LUMENS
0	2387	
5	2307	207
15	1146	307
25	237	117
35	77	51
45	29	25
55	12	11
65	4	5
75	1	2
85	0	0
95	0	0

Intensity Distribution

DISTANCE (FT.)	FOOTCANDLES (FC)	BEAM DIAMETER (FT.)
6'	66.3	3.0
8'	37.3	4.0
10'	23.9	5.0
12'	16.6	6.0
14'	12.2	7.0
16'	9.3	8.0

Beam Distribution: 30°

1. Dependent on surrounding temperatures
 2. Accuracy of rendering colors
 3. Color appearance of light source
 4. Colors present within the light source