

DATE

PROJECT

TYPE

R4 SERIES | 4-Inch Round Downlights: R4NC Universal New Construction Housing



Ceiling Opening: 4-7/8"
Ceiling Thickness: 1/2" - 1-1/2"

Side View

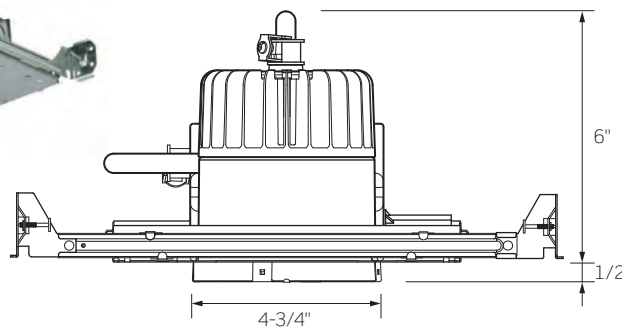

Top View

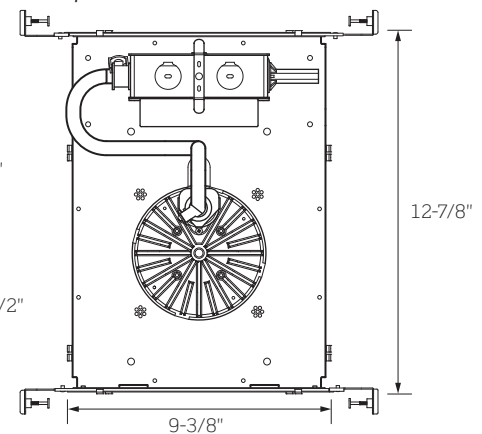

	R4NC1	R4NC2	R4NC3	R4NC4	R4NC5	R4NC6
WATTAGE	12W	16W	21W	30W	38W	45W
LUMEN OUTPUT ¹	1100Lm	1600Lm	2200Lm	3000Lm	3700Lm	4100Lm
COLOR TEMPERATURE	2700K / 3000K / 3500K / 4000K					
CRI	83 (80min) / 90+					
INPUT WATTAGE	12W	16W	21W	30W	38W	45W
INPUT CURRENT (A) 120V/277V/347V	.08/.04/.03	.12/.06/.04	.17/.08/.06	.23/.11/.08	.31/.14/.11	.36/.16/.12
INPUT VOLTAGE	120VAC / 277VAC / 347VAC, 50/60Hz					
Standard Driver	120VAC / 277VAC / 347VAC, 50/60Hz					
Lutron HiLume® Driver	120VAC, 50/60Hz				N/A	N/A
Lutron Eco-System® Driver	120VAC / 277VAC, 50/60Hz				N/A	N/A
eldoLED ECOdrive / SOLOdrive	120VAC / 277VAC, 50/60Hz					
DRIVER POWER FACTOR	> 0.90					
TOTAL HARMONIC DISTORTION (THD)	< 20%					
LISTINGS	cCSAus Certified to UL Standards; Suitable for Damp Locations cCSAus Certified to UL924 Standard for Emergency Lighting when specified with the Emergency Battery Backup option ENERGY STAR® Certified: – All wattage/lumen options are ENERGY STAR® Certified – ENERGY STAR® Certified Trims: C4322-PL, CN4322-PL, C4322-WHT, CN4322-WHT, C4322-CLR and CN4322-CLR (all beam distributions); –C (Clear Lens) and –SL (Sandblast Lens) Wet Location approved trim options are not ENERGY STAR® Certified – 347V Option, Lutron and eldoLED Dimming Options are not ENERGY STAR® Certified					
WARRANTY	Five (5) year replacement after date of purchase Emergency Battery Backup option covered by a one (1) year replacement guarantee after date of purchase					
SYSTEM RATING	50,000 Hours @ 70% Lumen Maintenance					

1. Approximate lumen output based on 3000K performance; see photometric test results for additional information

DATE

PROJECT

TYPE

R4 SERIES | 4-Inch Round Downlights: R4NC Universal New Construction Housing

ORDERING INFORMATION

Example Order: -

Housing/LED Series	Color Temp/CRI	Electrical	Dimming	Options
R4NC1 - 12W/1100lm	83 (80min) CRI	12 - 120V	D1 - TRIAC/ELV/0-10V Dimming	ER⁶ - Factory Installed 7W/200mA Emergency Battery Backup [Remote Test Switch]
R4NC2 - 16W/1600lm	27K - 2700K	27 - 277V	D2² - 347V 0-10V Dimming	
R4NC3 - 21W/2200lm	30K - 3000K	34¹ - 347V	D3³ - Lutron Hi-lume 1% 2-Wire Driver (120V Forward Phase Only)	
R4NC4 - 30W/3000lm	35K - 3500K		D4³ - Lutron Hi-lume 1% EcoSystem Driver with Soft-on, Fade-to-Black	
R4NC5 - 38W/3700lm	40K - 4000K		D6⁴ - eldoLED ECOdrive, 0-10V, 1% Dimming	
R4NC6 - 45W/4100lm	90+ CRI		D7⁴ - eldoLED ECOdrive, DALI, 1% Dimming	
	27KC - 2700K		D8⁴ - eldoLED SOLOdrive, 0-10V, 0.1% Dimming	
	30KC - 3000K		D9⁴ - eldoLED SOLOdrive, DALI, 0.1% Dimming	
	35KC - 3500K		DMX^{4,5} - eldoLED POWERdrive, DMX 0.0% Dimming	
	40KC - 4000K			

ER⁶: These Model Options are eligible for **SpeedShip**

1. TRIAC and ELV Dimming for 120V only
2. 0-10V Dimming only dimming available for 347V option; cannot be used with Emergency Battery Backup option
3. Lutron Hi-Lume 2-Wire Dimming available in 120V only, Eco-System available for both 120V and 277V. Lutron Dimming Options are available for Series 1 through 4 only (12W through 30W); not available for use with LED Series 5 or 6 (38W or 45W).
4. eldoLED Drivers are programmed for Linear Curve Dimming as standard; for Logarithmic Curve Dimming, consult factory
5. Verify DMX Driver and Control System compatibility with factory prior to ordering
6. Emergency Battery Backup option: 725 lumen nominal average for all wattages

ACCESSORIES

Standard Hanger Bars Supplied with Housing

HB-30 - T-Bar Hanger Set

RL-KIT - Commercial Mounting Brackets

HB-24 - 27-Inch Flat Hanger Bars for RL-KIT

HBC-24 - 25-Inch C-Channel Hanger Bars for RL-KIT in Grid Ceiling Construction

4-INCH SLOPE CEILING ADAPTERS

RSA4L-5-WHT - 5° Pitch

RSA4L-10-WHT - 10° Pitch

RSA4L-15-WHT - 15° Pitch

RSA4L-20-WHT - 20° Pitch

RSA4L-25-WHT - 25° Pitch

RSA4L-30-WHT - 30° Pitch

See "Trims for 4-Inch LED Downlights" Specification Sheet for compatible Trim information and details

DATE

PROJECT

TYPE

R4 SERIES | 4-Inch Round Downlights: R4NC Universal New Construction Housing

PRODUCT DETAILS

Construction

- Specification Grade 4-inch Round 16 Gauge Galvanized Steel New Construction Housing with Die-Cast Aluminum Heat Sink
- Quick-connect Light Engine
- LED Drivers are fully accessible from below the ceiling and can be easily removed
- Dual Nailer Hanger Bars are adjustable for 16- and 24-inch center joists (14-1/4- to 24-1/2- inch). Nailer Bars may be extended to rest on T-Bar ceilings; optional clip-on T-Bar Hangers available.
- Pre-wired Junction Box with three (3) 1/2-inch convenient Screwdriver Pry-outs and one (1) 1/2-inch x 3/4-inch concentric Knockout
- Output over-voltage, over-current and short circuit protection
- Approved for Through Circuit Wiring: max. eight (8) 12 AWG (4in/4out), wiring rated to 90°C
- Requires minimum 3-inch clearance around Housing from insulation material; thermal protection provided in case of improper insulation use

Performance Summary

- 2700K, 3000K, 3500K and 4000K CCTs; 80 CRI min., 83 typical; high 90+ CRI available
- Excellent fixture-to-fixture color consistency with a 3-step MacAdam Ellipse tolerance
- All R4 Downlights are available for non-dimming and dimming applications; for compatible Dimmers, refer to the Dimming Specification Sheet
- Flanged or Trimless Specification Grade Trims in several different styles and finishes available
- Trimless options require use of a Mud Frame (MF4, ordered separately) for securing housing and trim in 1/2- to 1-inch ceiling thicknesses only
- Trimless options cannot be used on Remodel Style Housings (R4RM) or with RSA4L Slope Ceiling Adapters
- UL8750 and Class 2 Compliant; RoHS Compliant, US only



The following Models are eligible for **SpeedShip**:

Housing: R4NC327K12D

Trim: C4322M-CLR

DATE

PROJECT

TYPE

R4 SERIES | Trims for 4-Inch LED Downlights

TRIMMED OPTIONS



C4322-PL
Platinum Reflector



C4322DF-SL
Satin Silver Painted Reflector



C4322 Series

Specification Grade Reflector

4-3/8-Inch ID, 5-11/16-Inch OD, 3-1/8-Inch Height

Specification Grade Reflector. For Wet Location approved trim, add “-C” for Clear Lens or “-SL” for Sandblast Lens after finish code.



C4322DF Series

ISOWET Dead Front Reflector Trim

4-3/8-Inch ID, 5-11/16-Inch OD, 3-1/8-Inch Height

Isolated, Wet Location approved Thermoplastic Reflector with Clear Glass Lens deeply regressed inside top of Reflector.

C4322N-CLR* - 35° Narrow Beam
Clear Specular Reflector

Quantity

C4322M-CLR* - 51° Medium Beam
Clear Specular Reflector

C4322W-CLR* - 80° Wide Beam
Clear Specular Reflector

C4322-PL* - 59° Platinum Reflector

C4322-PLWHE - 59° Platinum Wheat Reflector

C4322-WHT - 70° White Reflector

*Available with White Painted Flange, add “-WPF” to end of part number

C4322DF-SL* - Satin Silver Paint
C4322DF-WHT - Matte White Paint

Quantity

*Available with White Painted Flange, add “-WPF” to end of part number



C4323-CLR
Clear Reflector

C4323 Series

Lensed Wall Wash Reflector Trim

4-Inch ID; 5-11/16-Inch OD



CTR4325L-WHT-P
Floating Glass Disc
White Reflector



CTR4326L-CLR-P
Floating Glass Ring
Clear Reflector

CTR432*L Series

Floating Glass Reflector

4-3/8-Inch ID; 6-Inch OD

White Reflector with Floating Glass Disc, Clear Reflector with Floating Glass Ring; 1-1/4-inch drop from ceiling. Glass Ring has 3-1/2-inch center hole.

C4323-CLR* - Clear Reflector

Quantity

C4323-PL* - Platinum Reflector

C4323-WHT - White Reflector

*Available with White Painted Flange, add “-WPF” to end of part number

CTR4325L-WHT-P - Floating Glass Disc/
White Reflector

Quantity

CTR4326L-CLR-P - Floating Glass Ring/
Clear Reflector

: These Model Options are eligible for **SpeedShip**

DATE

PROJECT

TYPE

R4 SERIES | Trims for 4-Inch LED Downlights

TRIMMED OPTIONS, CONTINUED

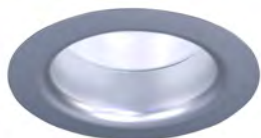

C4321-WHT-PL

White Reflector/Platinum Lower Cone



C4321-WHT-B

White Reflector/Black Baffle



C4321 Cone Series

Two Piece Reflector with Lower Cone and Flat Lens
3-7/8-Inch ID; 5-11/16-Inch OD. 3-1/8-Inch Height

Two Piece Reflector: Upper Reflector with Lower Cone. Includes one (1) LF20-CL Clear Glass Lens. Approved for Wet Locations when Glass Lens is installed.



C4321 Baffle Series

Two Piece Reflector with Lower Baffle and Flat Lens
3-7/8-Inch ID; 5-11/16-Inch OD. 3-1/8-Inch Height

Two Piece Reflector: Upper Reflector with Lower Baffle. Includes one (1) LF20-CL Clear Glass Lens. Approved for Wet Locations when Glass Lens is installed.

- | | |
|---|-----------------|
| C4321-CLR-CLR - Clear Reflector/
Clear Lower Cone | Quantity |
| C4321-CLR-PL - Clear Reflector/Platinum Lower Cone | |
| C4321-WHT-CLR - White Reflector/Clear Lower Cone | |
| C4321-WHT-PL - White Reflector/Platinum Lower Cone | |

- | | |
|---|-----------------|
| C4321-CLR-B - Clear Reflector/Black Lower Baffle | Quantity |
| C4321-CLR-P - Clear Reflector/White Lower Baffle | |
| C4321-WHT-B - White Reflector/Black Lower Baffle | |
| C4321-WHT-P - White Reflector/White Lower Baffle | |



C4327-CLR-PL

Clear Reflector/Platinum Lower Cone/
Regressed Prismatic Convex Lens



C4327-CLR-P

Clear Reflector/White Lower Baffle/
Regressed Prismatic Convex Lens



C4327 Cone Series

*Two Piece Reflector:
Lower Cone with Prismatic Convex Lens*
3-7/8-Inch ID; 5-11/16-Inch OD. 3-1/8-Inch Height

Two Piece Reflector with Lens: Upper Reflector with Lower Cone and Prismatic Convex Lens. Lens has 1-1/2-inch regress. Wet Location Listed.



C4327 Baffle Series

*Two Piece Reflector:
Lower Baffle with Prismatic Convex Lens*
3-7/8-Inch ID; 5-11/16-Inch OD. 3-1/8-Inch Height

Two Piece Reflector with Lens: Upper Reflector with Lower Baffle and Regressed Prismatic Convex Lens. Lens has 1-1/2-inch regress. Wet Location Listed.

- | | |
|---|-----------------|
| C4327-CLR-CLR - Clear Reflector/
Clear Lower Cone | Quantity |
| C4327-CLR-PL - Clear Reflector/Platinum Lower Cone | |
| C4327-WHT-CLR - White Reflector/Clear Lower Cone | |
| C4327-WHT-PL - White Reflector/Platinum Lower Cone | |

- | | |
|---|-----------------|
| C4327-CLR-B - Clear Reflector/Black Lower Baffle | Quantity |
| C4327-CLR-P - Clear Reflector/White Lower Baffle | |
| C4327-WHT-B - White Reflector/Black Lower Baffle | |
| C4327-WHT-P - White Reflector/White Lower Baffle | |

DATE

PROJECT

TYPE

R4 SERIES | Trims for 4-Inch LED Downlights

TRIMLESS OPTIONS

Trimless Options require use of Mud Frame accessory (MF4, ordered separately)



CN4322 *- CLR
Specular Clear Reflector
Multiple Beam Spreads



CN4322-PL
Platinum Reflector



CN4322 Series

Specification Grade Trimless Reflector
4-3/8-Inch ID; 4-3/4-Inch OD. 4-3/8-Inch Height

Specification Grade Specular Reflector. **Trim cannot be used on Remodel Housings (R4RM) or with Slope Ceiling Adapters (RSA4L). For use with 1/2- to 1-inch ceiling thicknesses only.** For Wet Location approved trim, add “-C” for Clear Lens or “-SL” for Sandblast Lens after finish code.

CN4323 Series

Trimless Lensed Wall Wash Reflector Trim
4-Inch ID; 4-3/4-Inch OD

Trim cannot be used on Remodel Housings (R4RM) or with Slope Ceiling Adapters (RSA4L). For use with 1/2- to 1-inch ceiling thicknesses only.

	Quantity
CN4322N-CL - 35° Narrow Beam Clear Reflector	
CN4322M-CLR - 51° Medium Beam Clear Reflector	
CN4322W-CLR - 80° Wide Beam Clear Reflector	
CN4322-PL - 59° Platinum Reflector	
CN4322-WHT - 70° White Reflector	

	Quantity
CN4323-CLR - Clear Reflector	
CN4323-PL - Platinum Reflector	
CN4323-WHT - White Reflector	

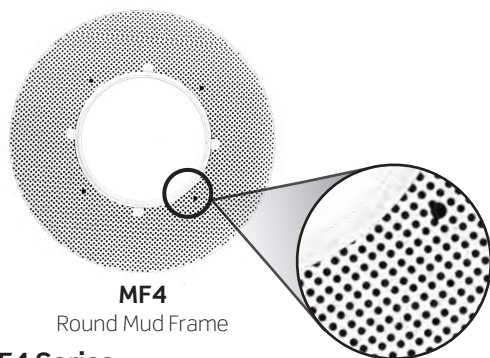

MF4
Round Mud Frame

MF4 Series

Round Mud Frame
10-Inch OD

Required for use with trimless options. Die-cast Ring with Steel Mesh Frame. Painted white.

	Quantity
MF4 - 4-Inch Mud Frame	

DATE

PROJECT

TYPE

R4 SERIES | 4-Inch Round Downlight Photometrics

R4NC630K12D / C4322N-CLR

Fixture Delivered Lumens: 4105.5
 Total Watts@120V: 45.2
 Lumens Per Watt: 90.8
 Center Beam Candle Power: 8153
 Beam Distribution: 35.5°
 Spacing Criterion: 0.60
 Color Rendering Index (CRI)¹: 83.3
 Color Temperature (CCT)²: 3079K
 Designed for 50,000 Hour Lamp Life³
 LM-63 Test No. G21070604
 LM-79 Test No. S21072001

DISTANCE (FT.)	FOOTCANDLES (FC)	BEAM DIAMETER (FT.)
6 FT	226.5	3.8
8 FT	127.4	5.1
10 FT	81.5	6.4
12 FT	56.6	7.7
14 FT	41.6	9.0
16 FT	31.8	10.2

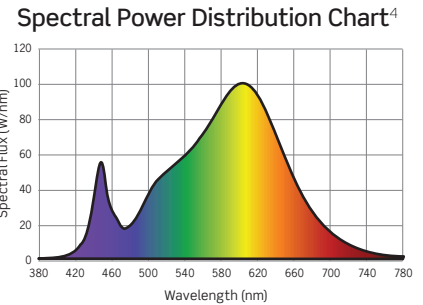
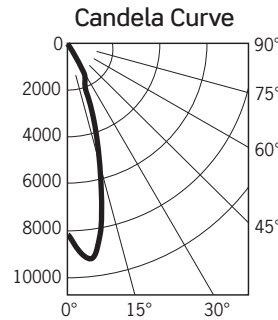

R4NC630K12D / C4322M-CLR

Fixture Delivered Lumens: 4176.6
 Total Watts@120V: 45.2
 Lumens Per Watt: 92.4
 Center Beam Candle Power: 5860
 Beam Distribution: 51.2°
 Spacing Criterion: 0.79
 Color Rendering Index (CRI)¹: 83.3
 Color Temperature (CCT)²: 3079K
 Designed for 50,000 Hour Lamp Life³
 LM-63 Test No. G21070605
 LM-79 Test No. S21072001

DISTANCE (FT.)	FOOTCANDLES (FC)	BEAM DIAMETER (FT.)
6 FT	162.8	5.8
8 FT	91.6	7.7
10 FT	58.6	9.6
12 FT	40.7	11.5
14 FT	29.9	13.4
16 FT	22.9	15.3

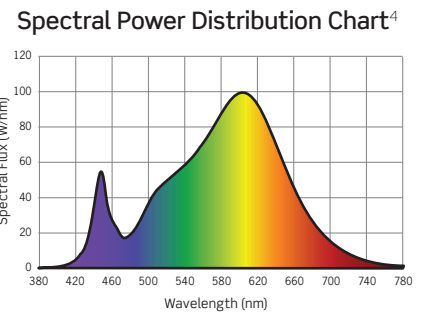
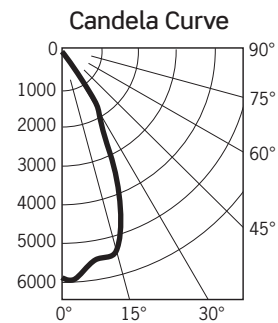

R4NC630K12D / C4322W-CLR

Fixture Delivered Lumens: 4220.8
 Total Watts@120V: 45.2
 Lumens Per Watt: 93.4
 Center Beam Candle Power: 2402
 Beam Distribution: 80.0°
 Spacing Criterion: 1.2
 Color Rendering Index (CRI)¹: 83.3
 Color Temperature (CCT)²: 3079K
 Designed for 50,000 Hour Lamp Life³
 LM-63 Test No. G21070602
 LM-79 Test No. S21072001

DISTANCE (FT.)	FOOTCANDLES (FC)	BEAM DIAMETER (FT.)
6 FT	66.7	10.1
8 FT	37.5	13.4
10 FT	24.0	16.8
12 FT	16.7	20.2
14 FT	12.3	23.5
16 FT	9.4	26.9

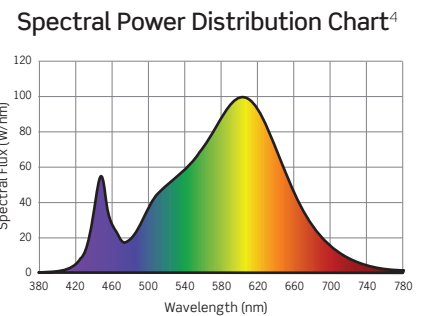
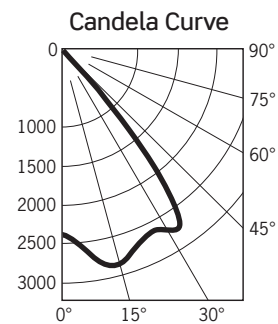

1. Accuracy of Rendering Colors 2. Color Appearance of Light Source 3. Dependent on Surrounding Temperatures 4. Colors Present within the Light Source

PHOTOMETRIC MULTIPLICATION FACTORS

Lumen output values fluctuate based on Color Temperature, Luminaire Wattage/Output and Trim Selection. To estimate lumen output of these various options, multiply 3000K results by the following:

CCT MULTIPLIERS			OUTPUT MULTIPLIERS					TRIM MULTIPLIERS	
CCT	STD CRI	HIGH CRI	12W/SERIES 1	16W/SERIES 2	21W/SERIES 3	30W/SERIES 4	38W/SERIES 5	C4322-PL	C4322-WHT
2700K	0.94	0.70	0.28	0.39	0.54	0.72	0.89	0.91	0.93
3000K	N/A	0.75							
3500K	1.0	0.81							
4000K	1.0	0.87							

DATE

PROJECT

TYPE

R4 SERIES | 4-Inch Round Downlight Photometrics

R4NC630K12D / C4322-PL

Fixture Delivered Lumens: 3781.4
 Total Watts@120V: 45.2
 Lumens Per Watt: 83.7
 Center Beam Candle Power: 4724
 Beam Distribution: 59.0°
 Spacing Criterion: 0.91
 Color Rendering Index (CRI)¹: 83.3
 Color Temperature (CCT)²: 3079K
 Designed for 50,000 Hour Lamp Life³
 LM-63 Test No. G21070601
 LM-79 Test No. S21072001

Intensity Distribution

DISTANCE (FT.)	FOOTCANDLES (FC)	BEAM DIAMETER (FT.)
6 FT	131.2	6.8
8 FT	73.8	9.0
10 FT	47.2	11.3
12 FT	32.8	13.5
14 FT	24.1	15.8
16 FT	18.5	18.1

Candela Curve

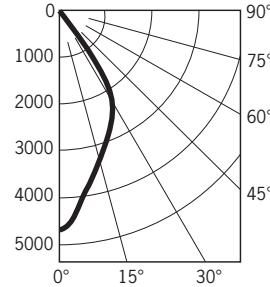

Spectral Power Distribution Chart⁴

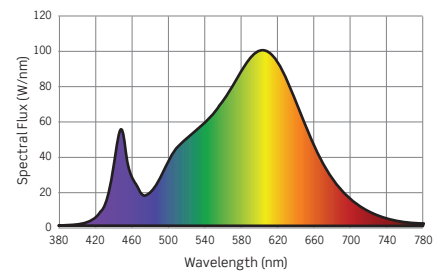

PHOTOMETRIC MULTIPLICATION FACTORS

Lumen output values fluctuate based on Color Temperature, Luminaire Wattage/Output and Trim Selection. To estimate lumen output of these various options, multiply 3000K results by the following:

CCT MULTIPLIERS			OUTPUT MULTIPLIERS					TRIM MULTIPLIERS	
CCT	STD CRI	HIGH CRI	12W/SERIES 1	16W/SERIES 2	21W/SERIES 3	30W/SERIES 4	38W/SERIES 5	C4322-PL	C4322-WHT
2700K	0.94	0.70	0.28	0.39	0.54	0.72	0.89	0.91	0.93
3000K	N/A	0.75							
3500K	1.0	0.81							
4000K	1.0	0.87							

DATE

PROJECT

TYPE

R4 SERIES | 4-Inch Round Downlight Photometrics

TM-30 DATA: R4NC630K12D / C4322M-CLR

ANSI/IES TM-30-18 Color Rendition Report Test No. S21072001

Colors are for visual orientation purposes only

R_f	86
R_g	97
CCT(K)	3079K
D_{uv}	0.0016
u^l	0.2473
v^l	0.5220

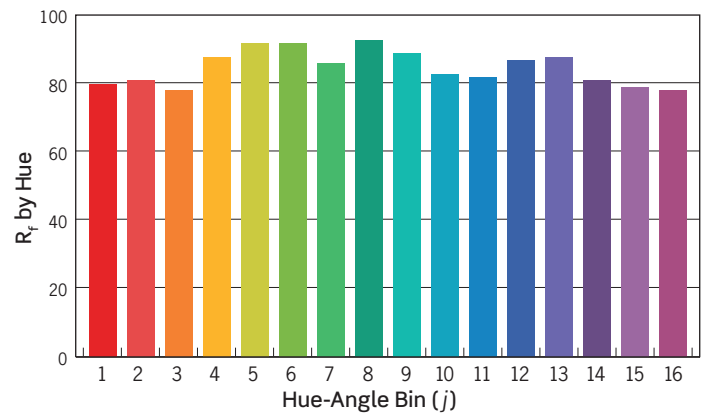
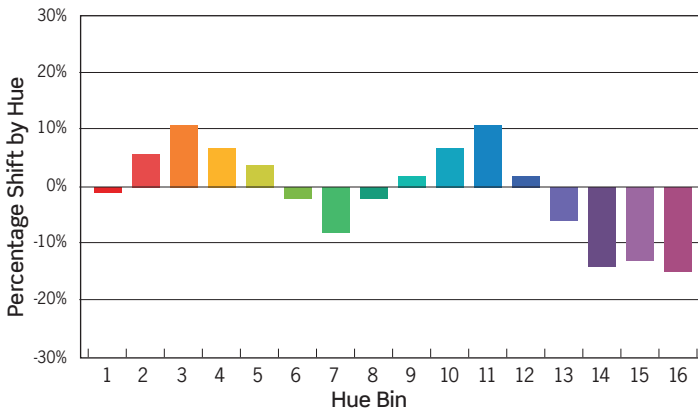
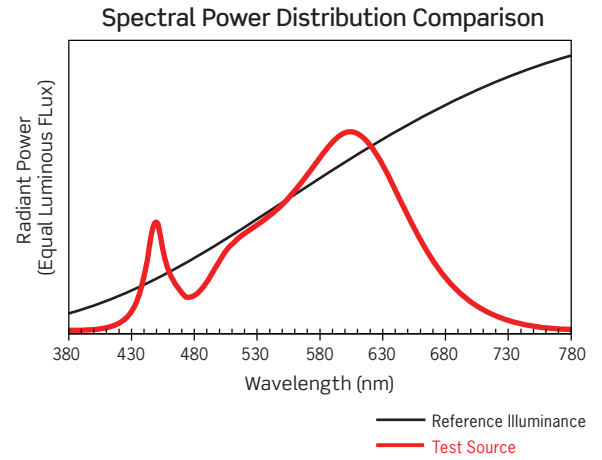
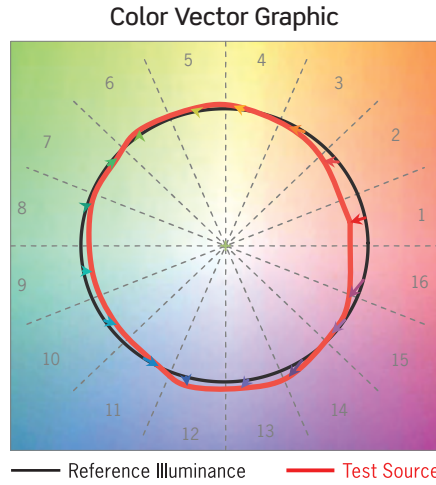

HUE BIN	1	2	3	4	5	6	7	8	9	10	11	12	13	14	15	16
HUE SHIFT	-1%	6%	11%	7%	4%	-2%	-8%	-2%	2%	7%	11%	2%	-6%	-14%	-13%	-15%
R_f VALUE	81	82	79	89	93	93	87	94	90	84	83	88	89	82	80	79

DATE

PROJECT

TYPE

R4 SERIES | 4-Inch Round Downlights: Dimming Specifications

- Incandescent 120V AC Dimmers adjust the light with *Forward Phase Control*, where the Dimmer “chops” the forward part of the AC Wave to deliver less or more power to the light source. No Neutral Wire Connection required.
- Electronic Low Voltage 120V AC Dimmers adjust the light with *Reverse Phase Control*, where the Dimmer “chops” the back part of the AC Wave to deliver less or more power to the light source. Neutral Wire Connection required.
- 0–10V DC Low Voltage Dimmers operate using two (2) Low Voltage Dimming Wires that are separate from the 120V or 277V AC Power. The Dimmer sends a Variable Output Voltage to the luminaire based upon the dimming level. 10V Corresponds to undimmed operation, 5V to 50% and so on. Switching On/Off is controlled with the Line Voltage Power Input to the Dimmer (120V or 277V AC). Dimming operation is controlled with the 0–10V DC Low Voltage Wiring Connection between the Dimmer and the LED Driver. The Control Signal runs on two (2) low voltage control wires color coded Violet and Pink/Gray.
- Lutron HiLume and EcoSystem Drivers provide continuous dimming from 1%–100%. For a complete list of compatible Dimmers and Controls, visit www.lutron.com
- Use DALI approved Controls for dimming eldoLED ECOdrive, 1% Dimming (Dimming Option D7 or MVD7) and eldoLED SOLOdrive, 0.1% Dimming (Dimming Option D9 or MVD9).

Manufacturer	Product	Model	TRIAC, ELV, 0-10V DIMMING	eldoLED ECOdrive 0-10V	eldoLED SOLOdrive 0-10V
			(12D, 27D or MVD Option*)	(12D6, 27D6 or MVD6 Option)	(12D8, 27D8 or MVD8 Option)
			Light Output	Light Output	Light Output
Leviton	IllumaTech	IPI06-1LZ	1%-100%	NA	NA
Leviton	SureSlide	6631-2	1%-100%	NA	NA
Leviton	Vizia	VPE06	9%-100%	NA	NA
Leviton	Trimatron	6683-IW	6%-100%	NA	NA
Leviton	Decora	6161	15%-100%	NA	NA
Leviton	SureSlide	6633-P	1%-100%	NA	NA
Leviton	IllumaTech	IPE04	6%-100%	NA	NA
Leviton	IllumaTech	IP710-DLX	NA	1%-100%	0.1%-100%
Cooper	Devine	DLC03P	1%-100%	NA	NA
Cooper	Skye	SLC03P	0%-100%	NA	NA
Cooper	Decorator	DAL06P	0%-100%	NA	NA
Pass & Seymour	Titan	CD4FB-W	NA	1%-100%	0.1%-100%
Synergy		ISD BC	NA	1%-100%	0.1%-100%
Watt Stopper	Miro Decorator	DCLV1	NA	1%-100%	0.1%-100%
Lutron	Ariadni	TGCL-153P	1%-100%	NA	NA
Lutron	Ariadni	TG-600P	13%-100%	NA	NA
Lutron	Diva	DVCL-153P	1%-100%	NA	NA
Lutron	Diva	DV600P	6%-100%	NA	NA
Lutron	Diva	DVELV303P	6%-100%	NA	NA
Lutron	Diva	DVTV	NA	1%-100%	0.1%-100%
Lutron	Faetra	FAELV500	12%-100%	NA	NA
Lutron	Lumea	LG600P	8%-100%	NA	NA
Lutron	Maestro	MAELV600	16%-100%	NA	NA
Lutron	Nova	NFTV	NA	1%-100%	0.1%-100%
Lutron	Nova T	NTFTV	NA	1%-100%	0.1%-100%
Lutron	Skylark	S-603PG	5%-96%	NA	NA
Lutron	Skylark	S600P	5%-100%	NA	NA
Lutron	Skylark	SELV300P	10%-100%	NA	NA
Lutron	Skylark	CT103P	9%-100%	NA	NA

*277V Triac Dimming is not available

NOTES

1. Testing was performed with a single luminaire connected to Dimmer.
2. Testing has been performed on these Dimmers, but this does not imply any warranty of compatibility.
3. Dimming performance can be influenced by different Loads, as well as variations in Dimmer Switches within the same Model.
4. Dimmer Maximum Load Rating with LED may differ from published Traditional Source Dimmer Ratings. Consult manufacturer for maximum Dimmer information.
5. Consult factory for additional dimming information.