

# LVR316-IC 10M

**StopAire Low Voltage Recessed Downlight  
 for Insulated Ceiling; Housing Only For Use With 10W Max. LED Lamps**

## Specifications/Features

### Housing/Mounting

For insulated ceilings (solid or suspended) conforming to Washington State Energy Code (WSEC) for low air infiltration.

StopAire rated for Air-Tight Applications.

J-Box cover is removable through ceiling aperture to access junction box. Junction Box has (4) 1/2" and (2) 3/4" knockouts with spring latch access plates.

"Sure-grip" spring permits inner housing to be lowered for adjustment to ceiling thickness.

Reversible dual extension hanger bars span 15" - 25-1/4" with integral holding spikes for easy mounting to wood joists. Hanger bars may be extended to rest on T-bar grid (optional clip-on T-bar hangers available).

### Lamp/Electrical

(1) 12V 10W Max. MR16 GU5.3 base

Porcelain Halogen socket with spring clip, rated 200°C.

Thermally protected Magnetic Class H Transformer is prewired, 120V in/12V out. Removeable through ceiling aperture.

Can be used with low voltage, magnetic dimming controls for optimal control of illumination.

### Trims

Baffle, multiplier, wall wash, accent and adjustable trim options available to suit a broad range of applications. See "Trims for 3" Low Voltage Recessed Housings" spec sheet for details.

On trims designed for use with MR16 lamps, ConTech Lighting provides a clear, tempered safety glass. This safety glass should only be used with open MR16 lamps, and not used with MR16 lamps that contain an integral glass lens.

### Warranty

This fixture is covered by ConTech's full one (1) year replacement guarantee after date of purchase.

Transformer has a one (1) year warranty.

### Labels/Usage

cCSAus Certified. Suitable for damp locations.

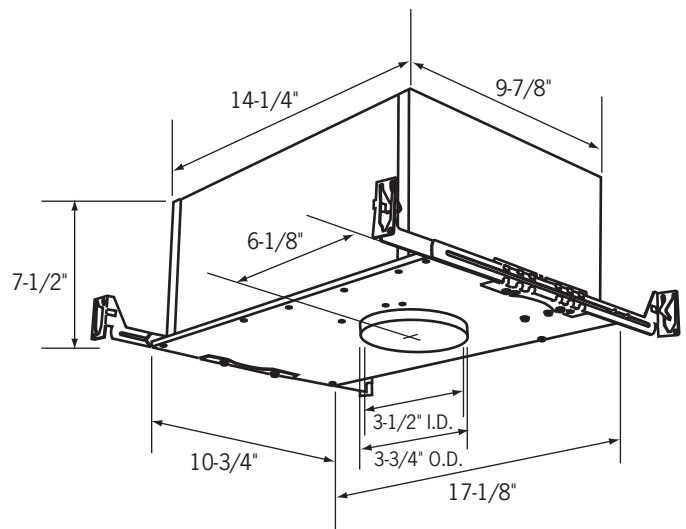

**Ceiling Opening: 3-7/8"  
 Max. Ceiling Thickness: 1"**

## Ordering Information

Example Order:

Housing/Voltage/Wattage

**LVR316-IC 10M - 120V/12V/10W**

Trims

**For Trims, see "Trims for 3" Low Voltage Recessed Housings" spec sheet.**

Options

- HB-24** - 27" Flat Hanger Set for RL-KIT
- HB-30** - Optional T-Bar Hanger Set
- HBC-24** - 25" C-Channel Hanger Set for RL-KIT
- RL-KIT** - Commercial Mounting Brackets

## Trims for 3" Low Voltage Recessed Housings

- All CTR3 Series Trims are cCSAus Certified and Suitable for Damp Locations; only Shower Trims are Wet Location Listed
- All Trims have White Trim finish unless specified
- For Trims designed for use with MR16 Lamps, ConTech Lighting provides a clear, Tempered Safety Glass Lens that should only be

used with open MR16 Lamps; not with MR16 Lamps that contain an integral Glass Lens

- If use of MR16 with Front Glass is required, remove the factory provided Safety Lens; Lens should also be removed when using MR16 LED Lamps
- Consult factory for LED Lamp compatibility

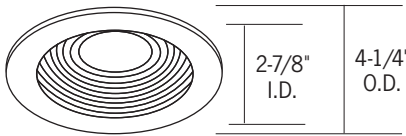

**CTR301 Series**  
*Adjustable Baffle*

15° Vertical swing, 45mm lens. Trim can hold up to two (2) lenses with stepped lens holder (included). Insert 45mm lens on lower level of lamp seat, insert 50mm lens onto higher level.

**CTR301-WHT** - Adjustable White Baffle



**CTR303N Series**  
*Slotted Wall Wash*

Internal 50° swing adjustment (25° from Nadir), external 358° rotation. Slot aperture permits maximum beam area adjustment for either wall wash or concealed accent lighting effects. Black interior surface.

**CTR303N-P** - White Slotted Wall Wash

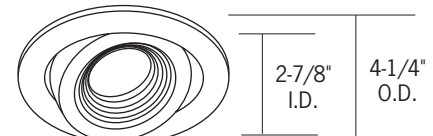

**CTR307 Series**  
*Adjustable Pin Spot*

Deep baffle for maximum lamp concealment. May be used as a pin spot style downlight or an adjustable accent light. 35° Vertical adjustment. 45mm Lens. Trim can hold up to two (2) lenses with stepped lens holder (included). Insert 45mm lens on lower level of lamp seat, insert 50mm lens onto higher level.

**CTR307-B** - Black Baffle, Black Trim



**CTR302 Series**  
*Adjustable Multiplier*

37° Vertical adjustment, 45mm lens. Trim can hold up to two (2) lenses with stepped lens holder (included). Insert 45mm lens on lower level of lamp seat, insert 50mm lens onto higher level.

- CTR302-B-BLKN** - Black Reflector, Black Trim
- CTR302-P-CLR** - Clear Reflector, White Trim
- CTR302-P-BLK** - Black Reflector, White Trim
- CTR302-P-WHT** - White Reflector, White Trim
- CTR302STCLR** - Clear Reflector, Brushed Stainless Steel Trim

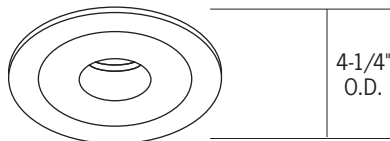

**CTR305 Series**  
*Pin Spot*

Downlight Only, 50mm Lens. Trim can hold up to two (2) lenses with stepped lens holder (included). Insert 45mm lens on lower level of lamp seat, insert 50mm lens onto higher level.

**CTR305-CLR** - Clear Cut-Off Reflector, White Trim

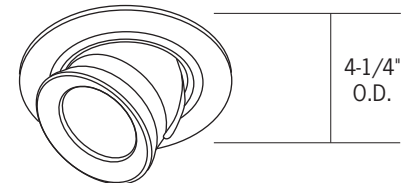

**CTR325 Series**  
*Fully Adjustable*

Die cast, fully adjustable, round lampholder and backplate. Easy relamping with twist-off front retaining ring. Unsurpassed aiming flexibility: 87° vertical, 359° rotational. 50mm lens.

**CTR325-B** - Black  
**CTR325-P** - White

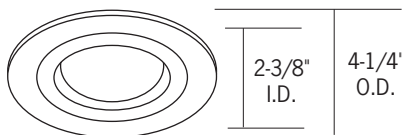

**CTR312**  
*Flat Glass*

Etched Glass for light diffusion.

**CTR312-P** - Flat Glass, White Trim



**CTR311FR**  
*Frosted Flat Glass Shower Light*

Shower light trim, double neoprene gasketed. cULus Listed for wet location.

**CTR311FR-P** - Frosted Flat Glass Shower Light, White Trim

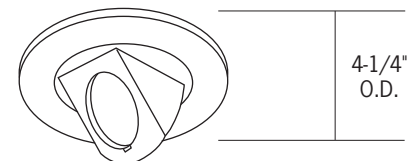

**CTR324 Series**  
*Fully Adjustable*

Unsurpassed aiming flexibility: 87° vertical, 359° rotational. Front access, spring latch lamp retainer ring, black finish (optional white retainer ring available: **1623/24 WHITE**, ordered separately). Exclusive stainless flat springs insure firm, close-to-ceiling mounting. Accepts only one 47mm lens; if louver is required (**FA-16 45MM**), remove safety lens and use front glass MR16 lamp.

**CTR324-P** - White